

U11 GND - 11 + - 10 + - 6 + - 8 + - 2 + - 9 + - 9 + - 4 + - 3 + - 2 +

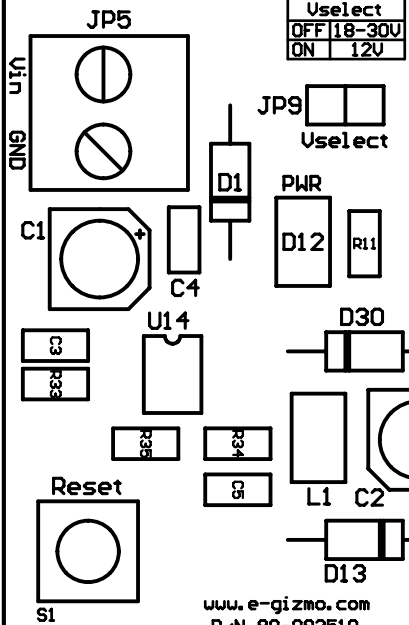

Uselect
OFF 18-30U
ON 12U

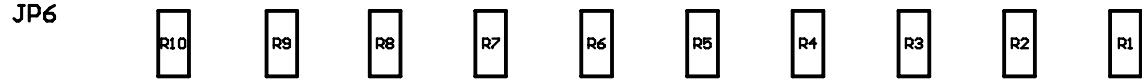
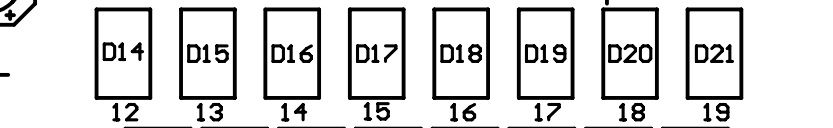
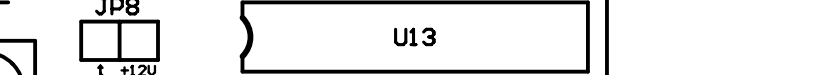
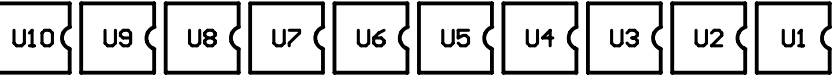
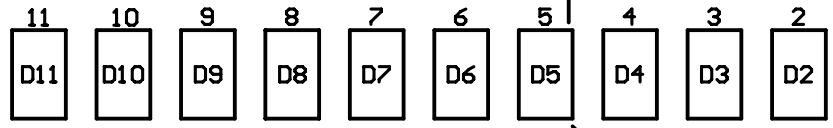

+12V
Arduino Vin

www.e-gizmo.com
P/N 80-092510

Isolated I/O
Board

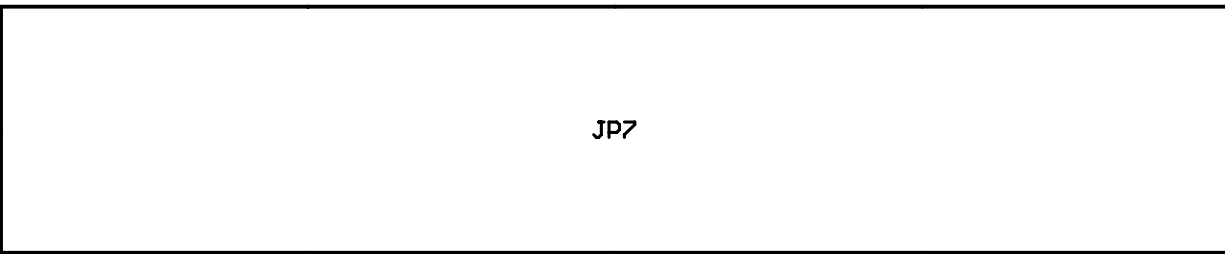
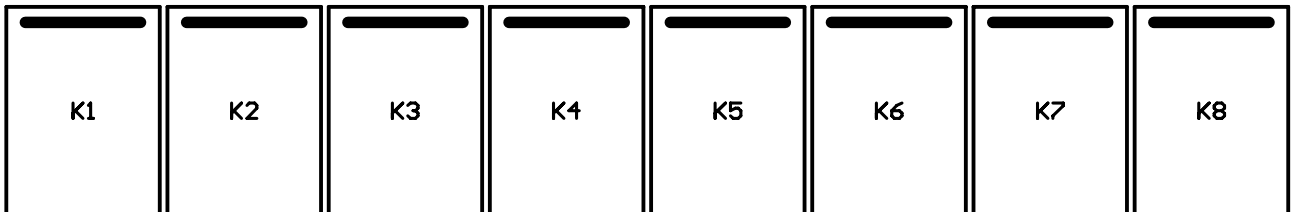
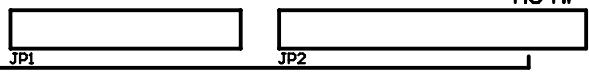

L12 L13 L14 L15 L16 L17 L18 L19